



## TRUE COMFORT IIII

This manual covers the following models:  
• **R251W** (Requires T955W)

### **Congratulations on purchasing a PRO1 Wireless System.**

This remote sensor was designed to the highest reliability and ease of use standards. Thank you for choosing Pro1.



#### **Caution:**

#### **Equipment damage hazard**

Do not operate the cooling system if the outdoor temperature is below 50° F (10° C) to prevent possible compressor damage.

### **Table of Contents** **Page**

Quick Reference .....	2
Mounting Locations .....	3
Mounting Options .....	4
Installing Batteries .....	5
Communication Setup .....	6
Technician Setup Menu .....	7
Remote Sensor Configuration .....	8
New Features On T955W .....	9
Specifications & Contact Us .....	10

### **Need Help?**

For assistance with this product please visit <http://www.pro1iaq.com> or call Pro1 Customer Care toll-free at 888-Pro1iaq (776-1427) during normal business hours (Mon-Fri 9 AM - 6 PM Eastern)

Una versión española de este manual puede ser descargada en [www.pro1iaq.com](http://www.pro1iaq.com)

## Getting to know your indoor remote sensor R251W



- ② **Glow in the Dark Light Button \***
- ③ **Temperature Setpoint Keys \*\***
- ④ **Remote Name**
- ⑤ **Run and Clean Keys \*\***

**\* NOTE ABOUT THE LIGHT BUTTON:**

This button is used to light up the display. **DO NOT** hold the light button down for longer than 3 seconds or you will enter the technician setup screens. If you inadvertently enter the tech setup press and release the light button a second time to exit the tech screens.

**\*\* NOTE ABOUT SETPOINT, RUN AND CLEAN KEYS:** These keys will only be shown if they have been turned on in Technician Setup menu.



### Mercury Notice:

All of Pro1's products are mercury free. However, if the product you are replacing contains mercury, dispose of it properly. Your local waste management authority can give you instructions on recycling and proper disposal.

### ① LCD

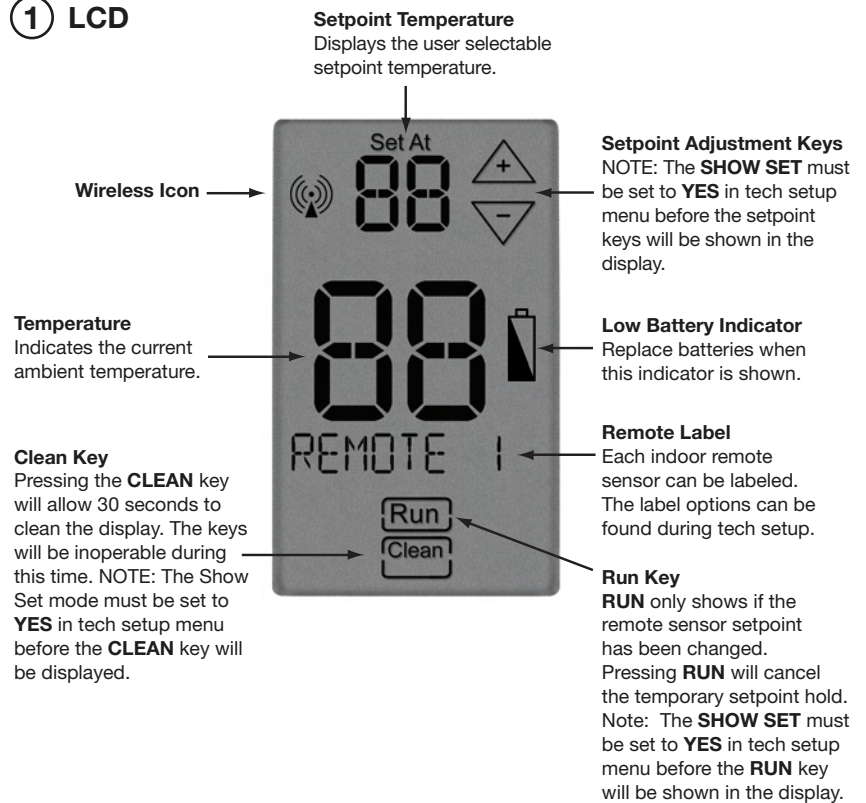

## Wireless Range

Range between the R251W and the T955W master thermostat is up to 100 feet with no obstructions and up to 50 feet in standard residential metal, brick, and concrete construction.

## Remote Sensor Locations

The remote sensor should be mounted or placed approximately 4 to 5 feet above the floor. Select an area with average temperature and good air circulation.

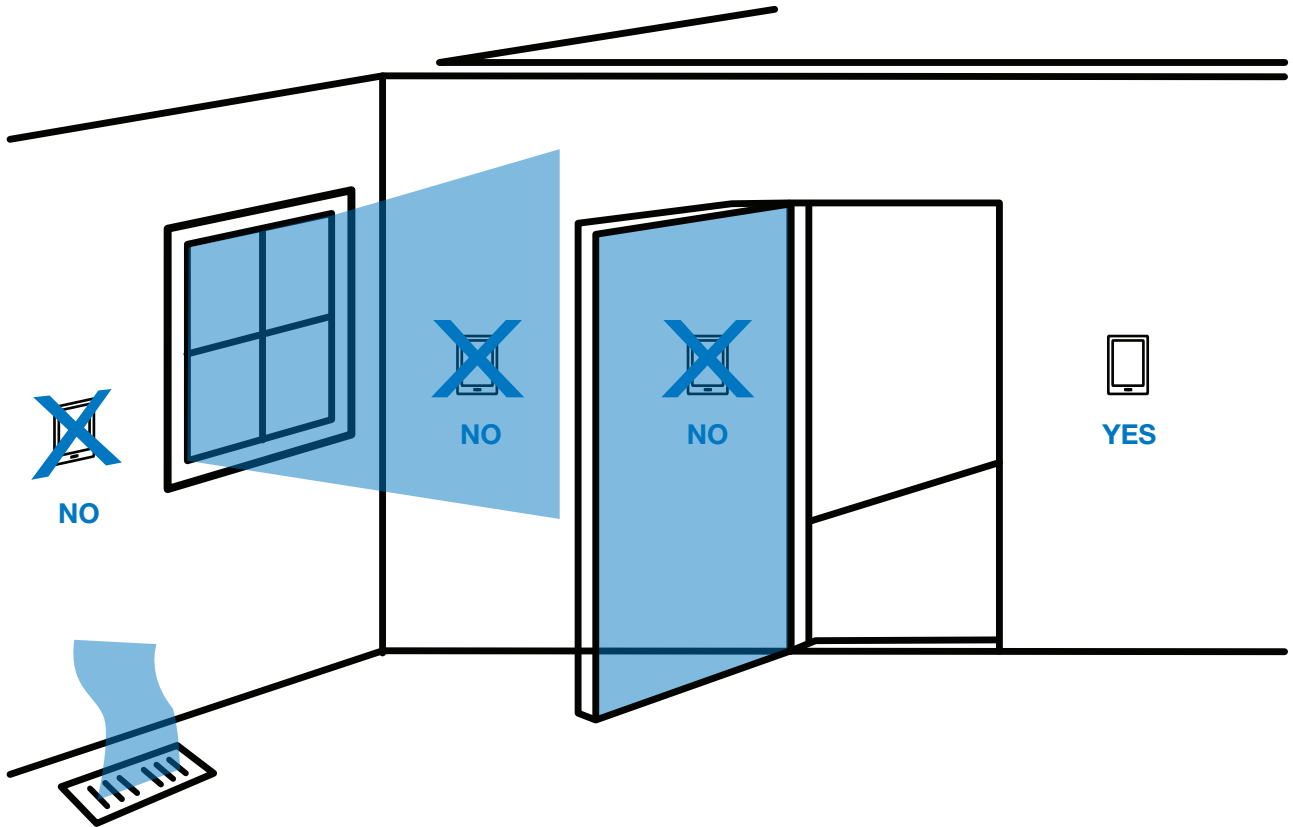

**Do not mount or place Remote Sensors** in locations:

- Close to hot or cold air ducts
- That are in direct sunlight
- With an outside wall behind the thermostat
- In areas that do not require conditioning
- Where there are dead spots or drafts (in corners or behind doors)
- Where appliances could radiate heat
- Do not set it next to or on hot appliances
- Do not put it in your pocket or hold in your hands for a long period of time. Body heat will distort the temperature reading.

## Wireless Range

Range between the R251W and the T955W master thermostat is up to 100 feet with no obstructions and up to 50 feet in standard residential metal, brick, and concrete construction.

## Wall Mount - Removeable

- 1 Mount T-bracket on the Wall.

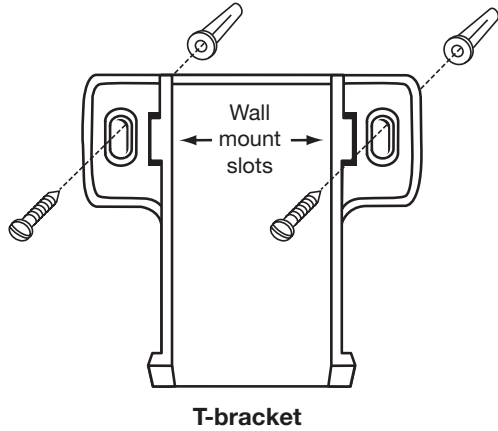

- 2 Slide the Remote Sensor over the mounted T-bracket.

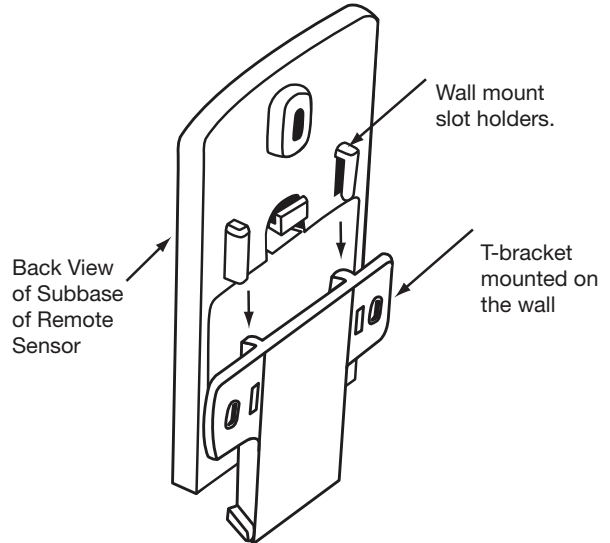

## Desk or Counter Option

- 1 Slide the T-bracket up into the slot holders.

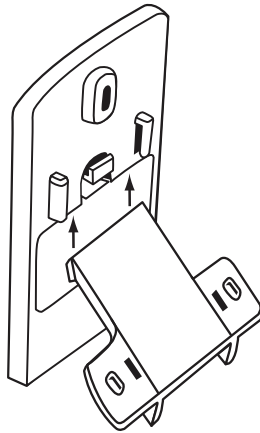

- 2 T-bracket will stop on the top of the slot holders.

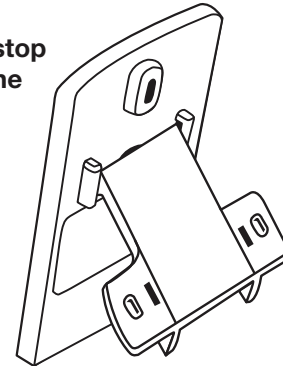

## Wall Mount - Permanent

- 1 Remove the R251W from the subbase.

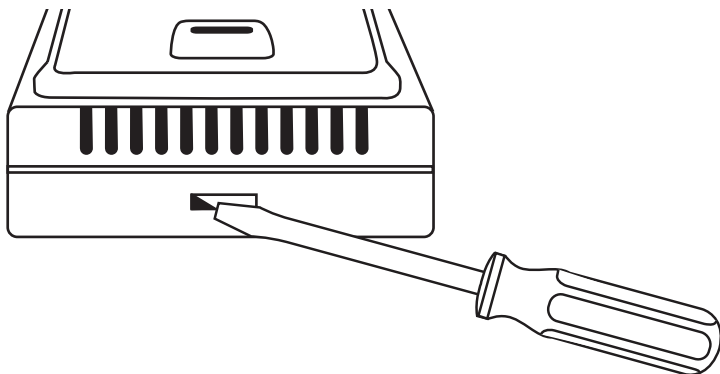

- 2 Mount subbase to the wall

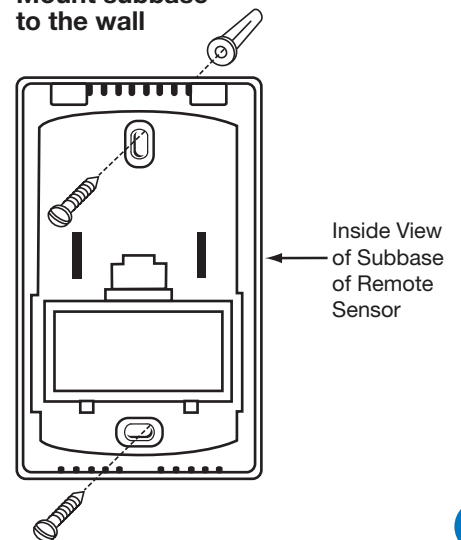

### Installing Batteries for Temporary Wall Mount or Table Placement

- 1 Use the finger tab on the back of the remote to remove the battery door.



- 2 Once you have removed the door from the back of the remote, insert 2 AA Alkaline batteries and replace the battery door.



### Inserting Batteries for Permanent Wall Mount

- 1 Remove the R251W from the subbase. The R251W is held on the subbase by a plastic tab on the bottom of the remote sensor. Push in with a small flat head screwdriver to remove the R251W from the subbase.

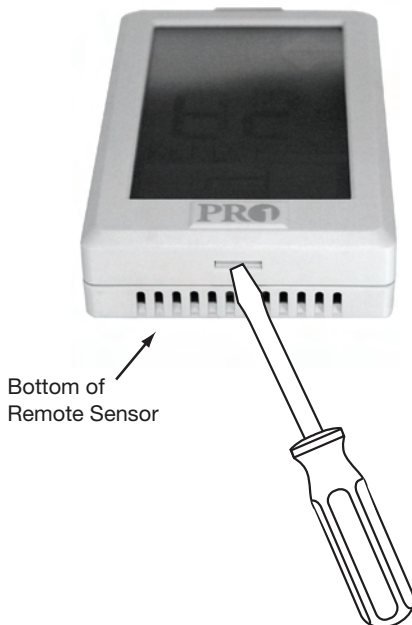

- 2 Once you have removed the R251W from the subbase, insert 2 AA Alkaline batteries.

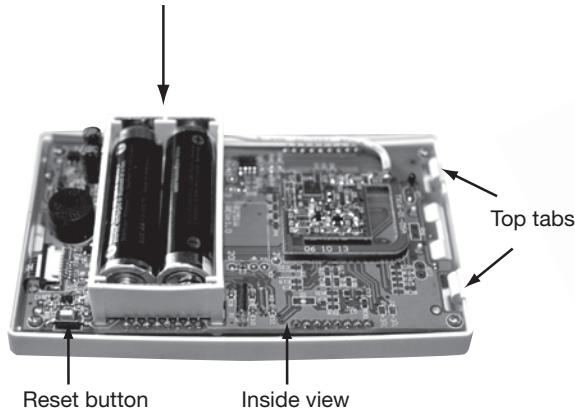

- 3 Attach the R251W to the subbase by aligning the two top tabs and then close as shown.

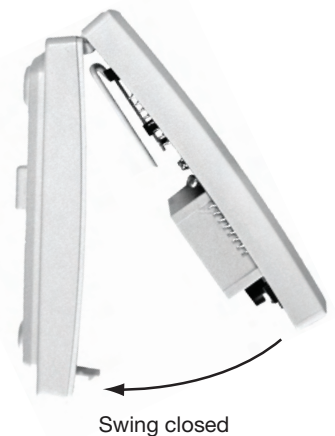

## Connecting to the Master Thermostat

### Easy communication link set up.

(R251W sends temperature information every 5 minutes.)

1. The **T955W** Master Thermostat Tech setting for the **Remote Sensor** must be set to **YES**. See the **T955W** manual for instructions.
2. Navigate the **T955W** to the **FINDING SENSORS** technician setup step and then select the zone you wish to connect for that remote. (See the **T955W** manual for instructions.)
3. On the Remote Sensor **R251W** hold the **LIGHT** button for 3 seconds to enter the tech setup screens. The first technician setup step is **ZONE**.
4. Choose the zone that matches the **T955W** that you currently want to connect. NOTE: You can only connect one **R251W** to each zone. *FOR EXAMPLE:* If you would like to connect two **R251W** to the **T955W**. Then connect the first **R251W** to **Zone 1**. And the second **R251W** to **Zone 2**.
5. While in the **ZONE** tech setup step on **R251W**, hold the light button down until the wireless icon flashes, approximately 3 seconds.
6. The **T955W** should now show the temperature of the remote sensor and the remote name. Your **R251W** has now established a communication link with the **T955W**.

### R251W Remote Sensor

Wireless icon      Light button

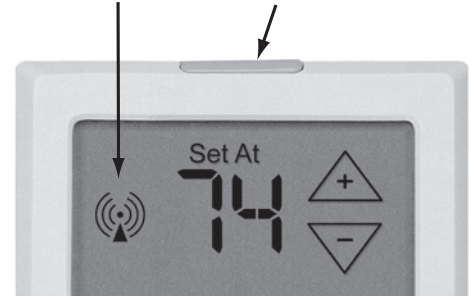

Example Step 3 and 5.

### T955W Master Thermostat

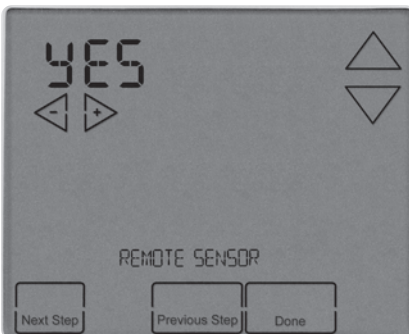

Example Step 1.

The **T955W Remote Sensor** set to **YES**. Then press **NEXT STEP**.

### T955W Master Thermostat



Example Step 2.

The **T955W Finding Sensor** zone numbers must match the zone number on the **R251W**.

### T955W Master Thermostat



Example Step 6.

The **T955W** now displays the name and the ambient temperature of the **R251W**.

## Technician Setup Menu









This remote sensor has a technician setup menu for easy installer configuration. To set up the remote for your particular application:

1. Press and hold the **LIGHT** button for 3 seconds. This 3 second delay is designed so that homeowners do not accidentally access the installer settings.
2. Configure the installer options as desired using the table below.

3. Use the  key to move to the next tech setup screen.

Use the  key to make adjustments to the settings.

**Note:** Press and release the light button when you want to exit the tech setup screens.

Tech Setup Steps						
Zone Selection	Remote Name	Show Set	Room Temperature Calibration	F or C	Low Temperature Setpoint Limit	High Temperature Setpoint Limit
<p>Selects which zone is used for connecting to the T955W.</p> <p>Only 1 remote can be used for each zone for a total of 4 remotes.</p>	<p>Selects a Name for the remote. This name will appear on the T955W when the T955W is displaying the remote's temperature.</p>	<p>Enabling this feature will allow the remote to temporarily override the T955W set point.</p>	<p>This feature allows the installer to change the calibration of the room temperature display. For example, if the thermostat reads 70° and you would like it to read 72° then select +2.</p>	<p>This feature sets the display temperature to read in either Fahrenheit or Celsius.</p>	<p>This feature allows you to set a minimum cool setpoint value. The setpoint temperature cannot be lowered below this value.</p>	<p>This feature allows you to set a maximum heat setpoint value. The setpoint temperature cannot be raised above this value.</p>
LCD Will Show						
						
Adjustment Options						
<p>Zone 1 Zone 2 Zone 3 Zone 4</p> <p>The Zone number on the R251W and the T955W must match in order to establish a connection.</p>	<p>Remote 1, Remote 2, Remote 3, Remote 4, Bedroom 1, Bedroom 2, Bedroom 3, Bedroom 4, Kitchen, Living Room, Hall, Family Room, Dining Room, Office, Study, Den, Loft, Upstairs</p>	<p><b>N</b> The remote is used as a sensor only and cannot change the current set point.</p> <p><b>Y</b> Enables the temperature adjustment keys allowing the user to temporarily override the T955W set point with the R251W remote.</p>	<p>You can adjust the room temperature display to read -4°F to +4°F above or below the factory calibrated reading.</p>	<p><b>F</b> for Fahrenheit <b>C</b> for Celsius</p>	<p>Use the  key to select the minimum cool setpoint.</p>	<p>Use the  key to select the maximum heat setpoint.</p>
Factory Default Settings						
ZONE 1	REMOTE 1	N	0	F	44°F	90°F

**Note:** Go to page 6 of this manual to see the instructions on how to connect the **R251W** to the **T955W Master Thermostat**.

**Note:** Tech setup cannot be entered if the **R251W** is in temporary hold mode. Press the **RUN** key to exit temporary hold.

## Sensor Only Mode

(**SHOW SET** tech screen set to **N**)

In sensor only mode (set to **N**) the remote will not allow you to change the set point. The current ambient temperature will be displayed and transmitted to the **T955W** every five minutes. The ambient temperature will be used for controlling when system average is selected and whenever it is given priority by the program in the **T955W**.



**R251W SHOW SET  
Tech Setup Screen**

## Adjustable Remote Mode

(**SHOW SET** tech screen set to **Y**)

In show set mode it will show the temperature setpoint arrows and the **CLEAN** key.

In this mode the **R251W** can be used to override the **T955W** current settings for 4 hours in addition to being used as temperature sensor.

### Override procedure.

Press the up or down arrow on the **R251W**.

The current ambient temperature will be displayed.

Adjust the temperature reading on the **R251W** to the desired set point.

The **T955W** will display the zone that currently has control and the Temperature at the remote. The word **REMOTE** will be displayed on the **T955W** to show that remote has overridden the program. Allow up to 1 minute for the **T955W** to acknowledge an override from an **R251W**.

Pressing **Run Schedule** on the **T955W** will return the system to the programmed schedule.

The **R251W** will show a **Run** key that can be pressed to return the **T955W** to the current programmed temperature, which cancels the hold.



**R251W SHOW SET  
Tech Setup Screen**

NOTE: The **R251W** will show the **Run** key for 4 hours even if the **T955W** is put back in to normal operation or overridden by a 2nd remote. However, the last device changed will have priority.

NOTE: The last remote or master changed will have priority.

NOTE: There is no permanent hold on the **R251W**, but you can select a permanent hold from the **T955W**.

### Example of programming a priority for the SLEEP time period:

In this example system we have 1 T955W on the main floor and 1 R251W in the Master Bedroom on the 2nd floor. During the setup process the R251W was named Bedroom 1. During WAKE, LEAVE and RETURN, the program should remain on system average. When on the SLEEP time period during programming, press NEXT ZONE until Bedroom 1 shows. During the SLEEP time period the other remotes in the house will be ignored and the system will be controlled only by the ambient temperature of the R251W in the master bedroom. The WAKE, LEAVE and RETURN temperature will be controlled by the system average.

### New Features on the T955W After R251W is Connected

#### NEXT ZONE KEY

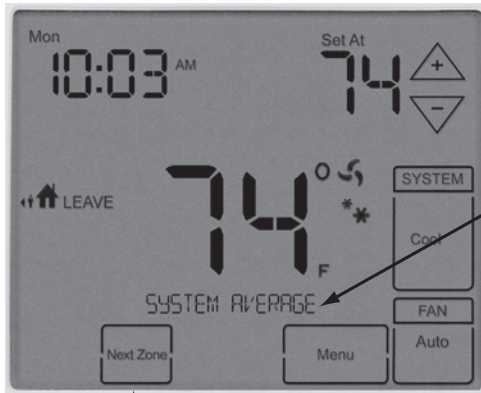

**NEXT ZONE** key cycles through ambient temperatures for connected zones.

In this example, the name of the zone currently having priority is **SYSTEM AVERAGE**.

**System average** is the average of all connected sensors.

**Local** is the ambient temperature of the **T955W**.

The name of the **R251W** can be displayed. This shows it has priority.

#### SETPOINT NOT DISPLAYED

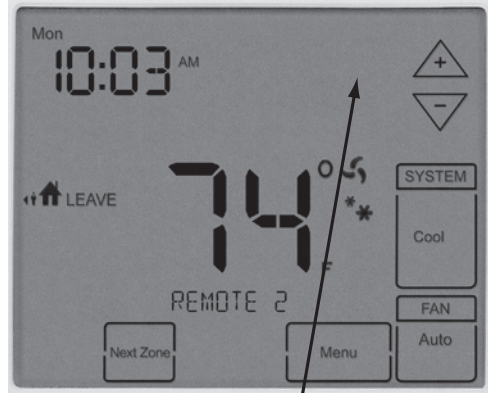

Setpoint will only be displayed for the zone currently being used by the program or in hold. Press the  $\Delta$  or  $\nabla$  to show the setpoint for adjustment.

#### THERMOSTAT HOLD (PERMANENT)

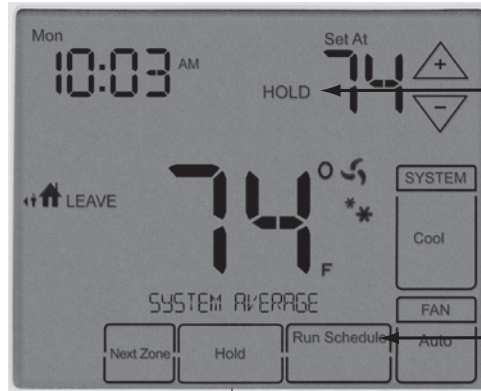

To put the thermostat into hold select system average or the zone you want to hold. Then use the arrows to adjust the setpoint. Then press the **HOLD** key.

**HOLD:** Indicates the T955W is in permanent **HOLD**. A permanent **HOLD** can be active for system average, local, or any **R251W**.

**Run Schedule:** Will cancel any holds and return the system to the program.

#### TEMPORARY HOLD (4 HOURS)

**REMOTE:** Indicates the **T955W** is in temporary hold. The setpoint will now display the temporary override setpoint.

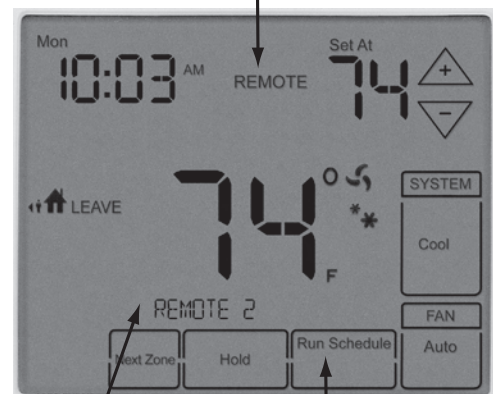

The name of the remote sensor will be displayed. In this example, it is **REMOTE 2**.

**Run Schedule:** Will cancel any holds and return the system to the program.

### Specifications

---

#### R251W Remote Sensor

The display range of temperature .....	32°F to 99°F (5°C to 35°C)
The control range of temperature .....	44°F to 90°F (7°C to 32°C)
Display accuracy .....	± 1°F
Power source .....	Battery power from 2 AA Alkaline batteries
Operating temperature .....	32°F to +105°F (0° to +41°C)
Operating humidity .....	90% non-condensing maximum
Dimensions of thermostat .....	2.75"W x 4.5"H x 1.375"D
Frequency .....	916 MHz
Sending Data .....	Every 5 minutes
Reading Temperature .....	Every 60 seconds

### Contact Us

---

#### Pro1 IAQ Inc.

1111 S. Glenstone  
Suite 2-100  
Springfield, MO 65804

**Toll-free:** 1-888-Pro1iaq (776-1427)

**Toll Number (Outside the USA):** 330-821-3600

**Web:** <http://www.pro1iaq.com>

**Hours of Operation:** Monday - Friday 9 AM - 6 PM Eastern